

# IR-JACKETED CO<sub>2</sub> INCUBATOR

# SHEL<sup>®</sup>LAB

110 – 120 Volts



## Installation - Operation Manual

SCO10A SCO5A

Pictured on the front cover, left to right: SCO10A, SCO5A

**Note:** The SCO10A requires two power outlets.

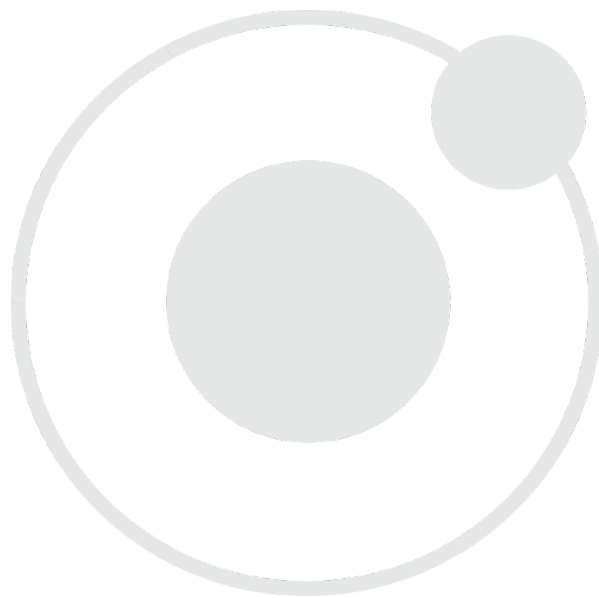

**Warning:** This product contains chemicals, including triglycidyl isocyanurate, known to the State of California to cause cancer as well as birth defects or other reproductive harm. For more information, go to [www.P65Warnings.ca.gov](http://www.P65Warnings.ca.gov).



**¡Advertencia!** Este producto contiene sustancias químicas, incluido el triglicidil isocianurato, que el estado de California sabe que causa cáncer, así como defectos de nacimiento u otros daños reproductivos. Para obtener más información, visite [www.P65Warnings.ca.gov](http://www.P65Warnings.ca.gov).



**Avertissement!** Ce produit peut vous exposer à des produits chimiques, dont l'isocyanurate de triglycidyle, reconnu par l'État de Californie pour provoquer le cancer, des anomalies congénitales ou d'autres problèmes de reproduction. Pour plus d'informations, visitez le site [www.P65Warnings.ca.gov](http://www.P65Warnings.ca.gov).

# SCO5A SCO10A AIR-JACKETED CO<sub>2</sub> INCUBATORS

120 Voltage                      OVC II 1500

Part Number (Manual): 4861730

Revision: May 5, 2026



SHEL LAB is a brand of Sheldon Manufacturing, INC, an ISO 9001 certified manufacturer.

## Safety Certifications

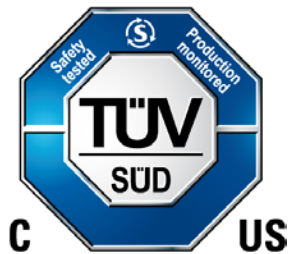

These units are TÜV CUE listed as air-jacketed CO<sub>2</sub> Incubators for professional, industrial, or educational use where the preparation or testing of materials is done at an ambient air pressure range of 22.14 – 31.3 inHg (75 – 106 kPa) and no flammable, volatile, or combustible materials are being heated.

The units were tested to the following standards:

- IEC 61010-1:2010/AMD1:2016
- IEC 61010-2-010:2019
- CSA C22.2 No. 61010-1:2012/A1:2018-11
- CSA C22.2 No. 61010-2-010:19
- UL 61010-1:2012/R:2019-07
- UL 61010-2-010:2019
- EN 61010-1:2010/A1:2019
- EN IEC 61010-2-010:2020
- Supplemented by: UL 61010-2-010:2015

# TABLE OF CONTENTS

<b>INTRODUCTION .....</b>	<b>7</b>
<i>Read this Manual.....</i>	7
<i>Safety Considerations and Requirements .....</i>	7
<i>Contacting Assistance.....</i>	8
<i>Manufacturing Warranty.....</i>	8
<i>Engineering Improvements.....</i>	8
<i>CO<sub>2</sub> Gas Supply.....</i>	9
<i>Reference Sensor Devices.....</i>	10
<b>RECEIVING YOUR UNIT .....</b>	<b>11</b>
<i>Inspect the Shipment.....</i>	11
<i>Orientation Photos.....</i>	12
<i>Recording Data Plate Information.....</i>	14
<b>INSTALLATION.....</b>	<b>15</b>
<i>Installation Procedure Checklist.....</i>	15
<i>Required Ambient Conditions .....</i>	16
<i>Required Clearances.....</i>	16
<i>Power Source Requirements .....</i>	17
<i>Lifting and Handling .....</i>	18
<i>Leveling.....</i>	18
<i>Install the Incubator.....</i>	19
<i>Deionized and Distilled Water.....</i>	19
<i>Installation - Clean and Disinfect.....</i>	19
<i>Install Chamber HEPA Filter and Duct.....</i>	20
<i>Shelving Installation.....</i>	21
<i>Connect to the CO<sub>2</sub> Supply.....</i>	22
<i>Access Port Stopper.....</i>	23
<b>GRAPHIC SYMBOLS.....</b>	<b>25</b>
<b>CONTROL PANEL OVERVIEW .....</b>	<b>27</b>
<b>OPERATION.....</b>	<b>29</b>
<i>Theory of Operation.....</i>	29
<i>Put the Incubator into Operation.....</i>	31
<i>Humidify the Incubator.....</i>	33
<i>Set the Temperature Setpoint.....</i>	34
<i>Muting the Audible Temperature Alarm.....</i>	35
<i>Automatic Door Cutoffs.....</i>	35
<i>Start a Flow of CO<sub>2</sub> .....</i>	36
<i>Set the CO<sub>2</sub> Setpoint.....</i>	37
<i>Muting the Audible CO<sub>2</sub> Alarm.....</i>	38
<i>No Gas Supply Alarm (NGS).....</i>	38
<i>Set the Over Temperature Safety.....</i>	39
<i>Loading Samples.....</i>	40
<i>Accessory Compatibility .....</i>	40
<i>Data Output Capabilities.....</i>	41
<i>Condensation and the Dew Point.....</i>	42
<b>USER MAINTENANCE.....</b>	<b>43</b>
<i>Cleaning and Disinfecting.....</i>	43
<i>Minimizing Contamination Exposure.....</i>	44
<i>Maintaining Atmospheric Integrity.....</i>	44
<i>Gas Lines and HEPA Filters.....</i>	45
<i>Electrical Components .....</i>	45

<i>Storing the Incubator</i> .....	45
<i>Replace the Chamber HEPA Filter</i> .....	46
<i>Calibrate the Temperature Display</i> .....	47
<i>Calibrate the CO<sub>2</sub> Display</i> .....	51
<b>UNIT SPECIFICATIONS</b> .....	<b>55</b>
<i>Weight</i> .....	55
<i>Dimensions</i> .....	55
<i>Max Shelves For Unit</i> .....	56
<i>Capacity</i> .....	56
<i>CO<sub>2</sub></i> .....	56
<i>Temperature</i> .....	56
<i>Power</i> .....	56
<b>PARTS LIST</b> .....	<b>57</b>
<i>Accessories</i> .....	58
<i>Ordering Parts and Accessories</i> .....	58

# TABLE OF CONTENTS



# INTRODUCTION

*Thank you for purchasing a SHEL LAB incubator. We know you have many choices in today's competitive marketplace when it comes to constant temperature equipment. We appreciate you choosing ours. We stand behind our products and will be here if you need us.*

## ***READ THIS MANUAL***

Failure to follow the guidelines and instructions in this user manual may create a protection impairment by disabling or interfering with the unit safety features. This can result in injury or death.

Before using the unit, read the manual in its entirety to understand how to install, operate, and maintain the unit in a safe manner. Ensure all end-users are given appropriate training before the unit begins service.

Keep this manual available for use by all end-users.

## ***SAFETY CONSIDERATIONS AND REQUIREMENTS***

Follow basic safety precautions, including all national laws, regulations, and local ordinances in your area regarding the use of this unit. If you have any questions about local requirements, please contact the appropriate agencies.

### **SOPs**

Because of the range of potential applications this unit can be used for, the end-user or their supervisors must draw up a site-specific standard operating procedure (SOP) covering each application and associated safety guidelines. This SOP must be written and available to all end-users in a language they understand.

### **Intended Applications and Locations**

This incubator is intended for constant temperature, humidified microbiological incubation applications in professional, industrial, and educational environments. The unit is not intended for use at hazardous or household locations.

### **Power**

Your unit and its recommended accessories are designed and tested to meet strict safety requirements.

- The unit is designed to connect to a power source using the specific power cord type shipped with the unit.
- Always plug the unit power cord into a protective earth grounded electrical outlet conforming to national and local electrical codes. If the unit is not grounded properly, parts such as knobs and controls can conduct electricity and cause serious injury.
- Do not bend the power cord excessively, step on it, or place heavy objects on it.
- A damaged cord can be a shock or fire hazard. Never use a power cord if it is damaged or altered in any way.
- Use only approved accessories. Do not modify system components. Any alterations or modifications to your unit not explicitly authorized by the manufacturer can be dangerous and are not covered by the manufacturing defect warranty.

# INTRODUCTION

## *CONTACTING ASSISTANCE*

Phone hours for Sheldon Customer Support are 6 am – 4:30 pm Pacific Coast Time (west coast of the United States, UTC -8), Monday – Friday. Please have the following information ready when calling or emailing Customer Support: the **model number**, **serial number**, and **part number** (see page 14).

support@sheldonmfg.com  
1-800-322-4897 extension 4  
(503) 640-3000 extension 4

Sheldon Manufacturing, INC.  
P.O. Box 627  
Cornelius, OR 97113  
USA

## *MANUFACTURING WARRANTY*

For information on your warranty and online warranty registration please visit:

- [sheldonmanufacturing.com/warranty](http://sheldonmanufacturing.com/warranty)

## *ENGINEERING IMPROVEMENTS*

Sheldon Manufacturing continually improves all of its products. As a result, engineering changes and improvements are made from time to time. Therefore, some changes, modifications, and improvements may not be covered in this manual. If your unit's operating characteristics or appearance differs from those described in this manual, please contact your SHEL LAB dealer or customer service representative for assistance.

# INTRODUCTION

**Note:** A CO<sub>2</sub> gas regulator must be purchased separately from the incubator. See page 58 for ordering information.

**Note:** Each incubation chamber in an SCO10A must have its own CO<sub>2</sub> supply.

## CO<sub>2</sub> GAS SUPPLY

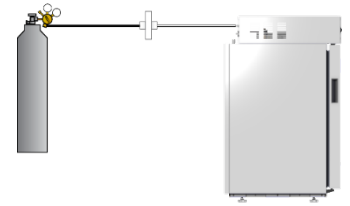

### Supply Required

The incubator must be connected to a carbon dioxide gas supply system in order to establish and maintain a CO<sub>2</sub>-enriched incubation chamber atmosphere. The supply can be a building CO<sub>2</sub> gas system or a supply cylinder (tank).

### Supply Quality

Use medical or food-grade CO<sub>2</sub>. The use of industrial CO<sub>2</sub> risks introducing contaminants into the chamber, may damage the incubator, and is not covered by the manufacturing defect warranty.

### Supply Source and Pressure

The incubator requires 15 – 20 psi of CO<sub>2</sub> gas pressure at the incubator intake port (labeled CO<sub>2</sub> to Chamber).

### Dual Stage Regulator

If connecting to a supply cylinder, **always use a dual-stage CO<sub>2</sub> pressure regulator**. During normal operations, the incubator injects small quantities of CO<sub>2</sub> to maintain the chamber gas concentration, and precise regulation of the gas input flow is vital for the incubator performance. Some single-stage regulators have two gauges. Make certain your regulator is a dual-stage regulator.



# INTRODUCTION

## REFERENCE SENSOR DEVICES

**Must be purchased separately**

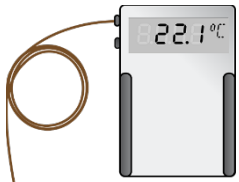

**Temperature Reference**

Reference sensor devices or a combined device are required for calibrating the incubator temperature and CO<sub>2</sub> displays.

Reference devices must meet the following standards:

- Accurate to at least 0.1°C
- Accurate to at least 0.1% CO<sub>2</sub>

The devices should be regularly calibrated, preferably by a third party.

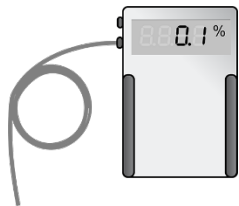

**CO<sub>2</sub> Reference**

### Temperature Probes

For temperature, use a digital device with wire thermocouple probes that can be introduced into the incubation chamber through the unit access port. Select thermocouples suitable for the application temperature you will be calibrating at.

### CO<sub>2</sub> Sampling

For best CO<sub>2</sub> accuracy, use a digital gas analyzer with sample tubing connecting to the incubator CO<sub>2</sub> sample port. The barbed adapter gas fitting on the sample port connects to a **3/16-inch (4.76 mm)** inner diameter (ID), 5/16-inch (7.94 mm) outside diameter (OD) tubing.

### Why Probes and Tubing?

Reference readings taken outside the chamber using wire temperature probes and CO<sub>2</sub> drawn through the sample port avoid chamber door openings. Openings disrupt the chamber temperature and CO<sub>2</sub> concentration level. Each disruption requires a **minimum 1-hour wait** to allow the atmosphere to re-stabilize before continuing.

### No Alcohol or Mercury Thermometers

Alcohol thermometers do not have sufficient accuracy to conduct accurate temperature calibrations. **Never place a mercury thermometer in the incubation chamber.** Always use thermocouple probes.

# RECEIVING YOUR UNIT

## INSPECT THE SHIPMENT

- When a unit leaves the factory, **safe delivery becomes the responsibility of the carrier.**
- **Damage sustained during transit is not covered by the manufacturing defect warranty.**
- Save the shipping carton until you are certain that the unit and its accessories function properly.

When you receive your unit, inspect it for concealed loss or damage to its interior and exterior. If you find any damage to the unit, **follow the carrier's procedure for claiming damage or loss.**

1. Carefully inspect the shipping carton for damage.
2. Report any damage to the carrier service that delivered the unit.
3. If the carton is not damaged, open the carton and remove the contents.
4. Inspect the unit for signs of damage. Use the orientation images in this chapter as references.
5. The unit should come with an Installation and Operation Manual.
6. Verify that the correct number of accessory items has been included.
7. Carefully check all packaging for accessory items before discarding.

### Included Accessories

Model	Humidification Pan	Access Port Stopper*	Leveling Feet
SCO5A	1	1	4
SCO10A	2	2	4



Model	Chamber HEPA Filter	Chamber Filter Cap	CO <sub>2</sub> Tubing Kit	Ceiling Air Duct
SCO5A	1	1	1	1
SCO10A	2	2	2	2



Model	Shelves	Shelf Slides	Shelf Standards	Power Cord
SCO5A	3	6	4	1
SCO10A	6	12	8	2



\*The access port stopper ships installed in each unit chamber access port.

# RECEIVING

## ORIENTATION PHOTOS

### SCO5A

#### Back of Unit

CO<sub>2</sub> In Port    Fuse in Power Inlet

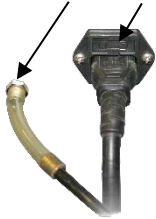

USB-Style Port

Control Panel

CO<sub>2</sub> Sample Port  
(Side of Unit)

Access Port  
(Side of Unit)

Chamber Door Handle

Door Gasket

Chamber Gasket

Ceiling Air Duct

Door Latch

Chamber HEPA Filter

Humidification Pan

Viewing Door  
(Glass)

Chamber Door

Viewing Doorknob



**SCO10A**

See the SCO5A depiction on the previous page for details on the individual incubators in the stack.



## *RECORDING DATA PLATE INFORMATION*

Record the unit **model number**, **serial number**, and **part number** below for future reference. Customer Support needs this information to provide accurate help during support calls and emails.

- **SCO5A**
  - The data plate is located on the inside of the incubation chamber door in the top right corner.
  
- **SCO10A**
  - The data plate for the SCO10A is located on the exterior, left-side of the incubator stack, on or just above the mounting brace.

### Data Plate Information

<b>MODEL NO:</b>	
<b>SERIAL NO:</b>	
<b>PART NO:</b>	

## *INSTALLATION PROCEDURE CHECKLIST*

For installing the unit in a new workspace location.

### **Pre-Installation**

- ✓ Verify a CO<sub>2</sub> gas supply source suitable for your application is available and can be connected to the incubator, page 9.
- ✓ Check that the required ambient conditions for the unit are met, page 16.
- ✓ Check that the spacing clearance requirements are met, page 16.
  - Unit dimensions may be found on page 52.
- ✓ Check that a suitable electrical outlet and power supply is present, page 17.

### **Install the incubator in a suitable location**

- ✓ Review the lifting and handling instructions, page 18.
- ✓ Install the unit leveling feet, page 18.
- ✓ Install the incubator in its workspace location, page 19.

### **Set up the incubator for use**

- ✓ Clean and disinfect the unit and accessories (except the HEPA filter), page 19.
- ✓ Install the chamber HEPA filter and ceiling air duct in the incubation chamber, page 20.
- ✓ Install the shelving, page 21.
- ✓ Connect the incubator to the CO<sub>2</sub> gas supply source, page 22.
- ✓ Verify that the silicone stopper is installed in the access port inside each incubation chamber, page 23.

# INSTALLATION

## *REQUIRED AMBIENT CONDITIONS*

These units are built for use indoors at room temperatures between **15°C and 30°C (59°F and 86°F)**, at no greater than **80% Relative Humidity** (at 25°C / 77°F). The ambient temperature should not change by 2°C (3.6°F) or more during operation.

Operating outside these conditions may affect the incubator temperature performance.

When selecting a location to install the unit, consider all environmental conditions that can adversely impact its temperature performance. These include:

- Proximity to ovens, autoclaves, and any device that produces significant radiant heat
- Heating and cooling vents or other sources of fast-moving air currents
- High-traffic areas
- Direct sunlight

## *REQUIRED CLEARANCES*

These clearances are required to provide airflows for ventilation and cooling.

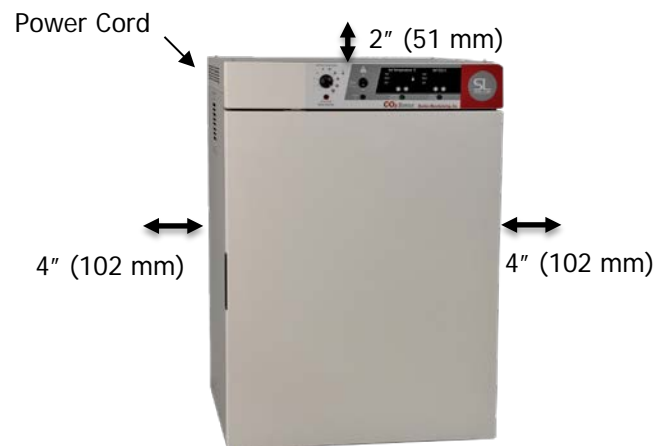

**4 inches (102 mm)** of clearance is required on the sides and back.

**2 inches (51 mm)** of headspace clearance is required between the top of the unit and any overhead partitions.

# INSTALLATION

## POWER SOURCE REQUIREMENTS

When selecting a location for the unit, verify each of the following requirements is satisfied.

**Power Source:** The power source must match the voltage and amperage requirements listed on the unit data plate. These units are intended for **110 – 120 volt, 50/60 Hz** applications at the following amperages:

Model	Amperage	Model	Amperage
SCO5A	6.0 Amps	SCO10A	6.0 Amps

\*The SCO10A comes with two power cords. It requires **6.0 amps** for each cord.

- The wall power source must be protective earth grounded.
- **The unit may be damaged if the supplied voltage varies by more than 10% from the data plate rating.**
- Use a separate circuit to prevent loss of the unit due to overloading or circuit failure.
- **The recommended wall circuit breakers for these units are 15 amps.**
- The wall power source must conform to all national and local electrical codes.

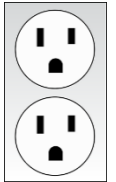

Standard  
NEMA 5-15R  
wall socket

**Power Cord:** The unit must be positioned so that all end-users can quickly unplug the cord in the event of an emergency.

- Each unit is provided with a **125-volt, 15 amp, 9ft 5 in (2.86m) NEMA 5-15P** power cord. Always use this cord or an identical replacement.



**Fuses:** Each unit ships with a fuse installed in the power cord inlet.

- The fuse must be installed and intact for the unit to operate.
- Always find and fix the cause of a blown fuse prior to putting the unit back into operation.
- Fuse type:
  - 250V T10 Amp, 5x20mm



# INSTALLATION

## *LIFTING AND HANDLING*

The unit is heavy. Use appropriate lifting devices that are sufficiently rated for these loads. Follow these guidelines when lifting the unit.

- Lift the unit only from its bottom surface.
- Doors, handles, and knobs are not adequate for lifting or stabilization.
- Restrain the unit completely while lifting or transporting so it cannot tip.
- Remove all moving parts, such as shelves and trays, and lock doors in the closed position during transfers to prevent shifting and damage.

## *LEVELING*

Install the leveling feet in the 4 corner holes on the bottom of the unit. The unit must be level and stable for safe operation.

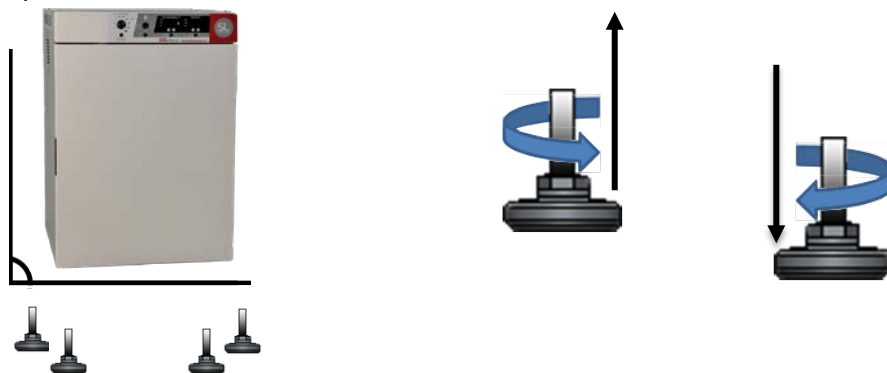

---

**Note:** To prevent damage when moving the unit, turn all 4 leveling feet so that the leg of each foot sits inside the unit.

---

## *INSTALL THE INCUBATOR*

Install the unit in a workspace location that meets the criteria discussed in the previous entries of the Installation section.

## *DEIONIZED AND DISTILLED WATER*

**Do not use deionized water** to clean the unit, even if DI water is readily available in your laboratory.

- The use of deionized water may corrode metal surfaces and **is not covered by the manufacturing defect warranty**.
- The manufacturer recommends the use of distilled water in the resistance range of 50K Ohm/cm to 1M Ohm/cm, or a conductivity range of 20.0 uS/cm to 1.0 uS/cm, for cleaning applications.

## *INSTALLATION - CLEAN AND DISINFECT*

The manufacturer recommends cleaning the shelving, ceiling air duct, and chamber prior to installing the shelving and ceiling duct in the chamber.

- The unit was cleaned at the factory but may have been exposed to contaminants during shipping.
- Remove all wrappings and coverings from shelving and the ceiling air duct prior to cleaning and installation. **Do not clean the shelving with deionized water.**
- **Do not clean the chamber HEPA filter.**
- Please see the [Cleaning and Disinfecting](#) procedure on page 43 in the User Maintenance chapter for information on how to clean and disinfect without damaging the unit.

# INSTALLATION

## *INSTALL CHAMBER HEPA FILTER AND DUCT*

**Note:** Exercise caution to avoid striking the sensors and blower fan wheel on the chamber ceiling when installing the duct.

**Note:** The incubator must be turned off and unplugged when carrying out this procedure.

The ring-style chamber HEPA filter traps particulates, as well as isolating and killing airborne microbes in the incubation chamber.

Perform the following steps to install the filter and ceiling air duct.

1. Snap the chamber HEPA filter to the mounting collar on the chamber ceiling air duct.
  - It may be necessary to tilt the filter to one side or the other.
2. Snap the filter cap to the HEPA filter.
3. Move the air duct into the incubation chamber with the attached HEPA filter facing down.
4. Mount the back of the air duct on the rear chamber mounting pins, one pin at a time.
5. Mount the front of the duct on the front chamber mountings, one at a time.

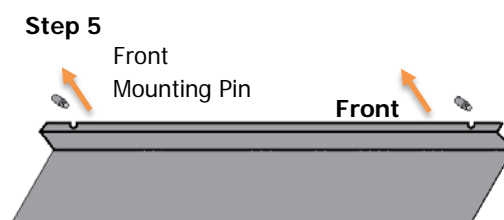
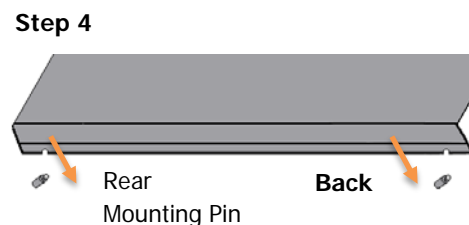
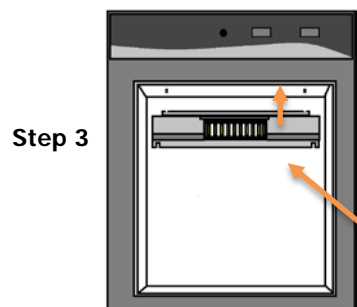
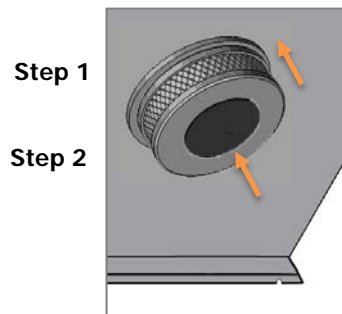
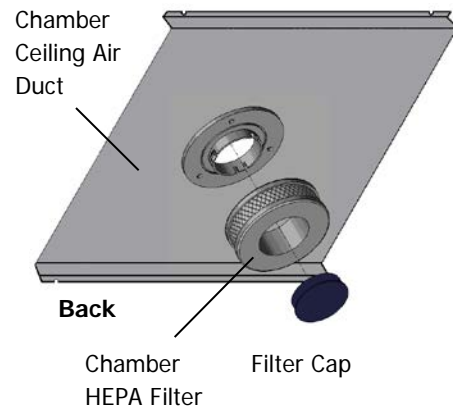

# INSTALLATION

## *SHELVING INSTALLATION*

Install the shelving and in the incubation chamber.



1. Install the shelf standard rails.

- Align the keyhole slot of the standard with the mounting peg on the side of the chamber wall.
- Mount the shelf standard.



2. Install the shelf slides.

- Insert the shelf slide into the shelf standard using a rocking motion.
- The shelf slide will sit level when correctly installed.



3. Install the shelves.

- Slide into position.

### **Shelving Installation**

# INSTALLATION

## CONNECT TO THE CO<sub>2</sub> SUPPLY

**Note:** See page 9 for CO<sub>2</sub> supply requirements.



Dual-Stage CO<sub>2</sub>  
Pressure Regulator



Optional Tubing Kit  
with Inline HEPA Filter

### CO<sub>2</sub> to Chamber



Connects to 3/16"  
(4.76 mm) ID Tubing

### SCO5A

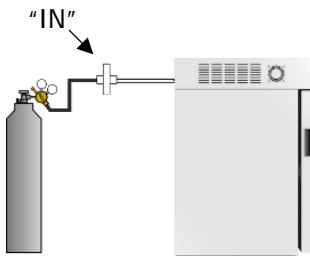

### SCO10A

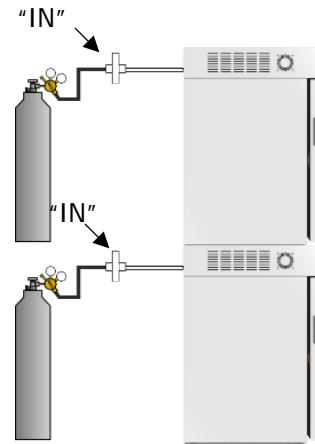

1. Connect the supply source to each incubator.
  - The SCO10A requires a CO<sub>2</sub> supply for each chamber.
2. Do not initiate a flow of CO<sub>2</sub> to the incubator at this time.

**End of Procedure**

## *ACCESS PORT STOPPER*

Each incubator ships with a silicone stopper installed in the access port located on the right side of the incubation chamber interior.











- The stopper should always be **installed inside the chamber** to obtain the best temperature uniformity and prevent condensation from forming inside the port.
  - Do not install the stopper on the outside of the incubator.
- Wires for thermocouples and other sensor probes may be introduced into the chamber through the access port. The stopper may be put in place over the wires.
- The unit will not meet its temperature or CO<sub>2</sub> specifications without the stopper installed.



# GRAPHIC SYMBOLS

The unit is provided with graphic symbols on its exterior. These identify hazards and adjustable components as well as important notes in the user manual.

Symbol	Definition
	Consult the user manual Consulter le manuel d'utilisation
	Temperature display Indique l'affichage de la température
	Over Temperature Limit system Thermostat température limite contrôle haute
	AC Power Repère le courant alternatif
	I/ON O/OFF I indique que l'interrupteur est en position marche. O indique que le commutateur est en position d'arrêt.
	Protective earth ground Terre électrique
	Adjusts UP and DOWN Ajuster le haut et vers le bas
	Potential shock hazard Risque de choc électrique
	Recycle the unit. Do not dispose of in a landfill. Recycler l'unité. Ne jetez pas dans une décharge.



# CONTROL PANEL OVERVIEW



Control Panel

## Power Switch

Power is supplied and the green Power On light illuminates when the switch is in the ( I ) ON position.



## Over Temp Safety

This graduated dial sets the mechanical heating cut off for the Over Temperature Limit system (OTL). The OTL helps prevent unchecked heating of the chamber in the event of an electronics failure or external heat spike. For details, please see the [Over Temp Safety System](#) description in the Theory of Operations (page 30.)

The red Over Temp Safety Activated light illuminates when the OTL system cuts off heating to the incubation chamber by rerouting power away from the heating elements.



## Set Temperature Display and Controls

Shows the current chamber temperature. The **Up** and **Down** arrow buttons are used to access the Temperature Setpoint (SP) or Calibration Offset (C O) display modes and input the temperature setpoint or calibration adjustment value.

Red LED alarm indicators marked High and Low illuminate whenever the temperature deviates by  $\pm 1^{\circ}\text{C}$  or greater from the current setpoint. The yellow LED marked Mute illuminates whenever an audible deviation alarm is being muted. See the [Muting the Audible Temperature Alarm](#) entry on page 35 for more information.

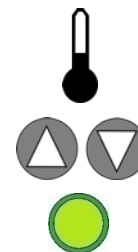

The green Heating Activated light illuminates when the unit is calling for power to the heating elements.

## Set CO<sub>2</sub> Display and Controls

**Set CO<sub>2</sub> %** Shows the current concentration of CO<sub>2</sub> as a percentage of the incubation chamber atmosphere. The display has a range of OFF (0%) to 20% and an accuracy of 0.1%. The display shows "LO" until the CO<sub>2</sub> sensor registers a concentration in the chamber greater than 0%. A few minutes of CO<sub>2</sub> injections may be required when initially starting the unit.



The **Up** and **Down** arrow buttons are used to access the CO<sub>2</sub> Setpoint (SP) or Calibration Offset (C O) display modes and input the CO<sub>2</sub> setpoint or calibration adjustment value.

Red LED alarm indicators marked High and Low illuminate whenever the CO<sub>2</sub> concentration deviates by  $\pm 1\%$  or greater from the setpoint. The yellow LED marked Mute illuminates whenever an audible deviation alarm is being muted. See the [Muting the Audible CO<sub>2</sub> Alarm](#) entry on page 37 more information.



The green CO<sub>2</sub> Injecting light illuminates when the incubator is injecting CO<sub>2</sub> into the incubation chamber. Injections are accompanied by a clicking sound that is the CO<sub>2</sub> solenoid opening and closing.

## *THEORY OF OPERATION*



### **Heating**

When powered, the incubator heats to and maintains a user-selected target setpoint in the incubation chamber. The incubator senses the chamber air temperature using a solid-state probe mounted on the chamber interior wall. When the incubator detects that the chamber temperature has dropped below the target setpoint, it pulses power to heating elements on the surface of the air-jacket insulation space and in the outer chamber door. Insulation is provided by the air-filled jacket surrounding the incubation chamber on the top, bottom, back, and left and right sides.

The incubator uses Proportional – Integral – Derivative (PID) control to avoid significantly overshooting the setpoint. This means the rate of heating slows as the chamber temperature approaches the target temperature. If the chamber temperature is above the setpoint, the incubator uses minimum heating to control the rate of cooling and avoid dipping below the setpoint.

Additionally, the PID loops optimize heating rates for the temperature environment around the incubator. If the incubator is operating in a cool room, it will increase the length of heating pulses to compensate. Likewise, when operating in a warm room the incubator uses shorter pulses. If the ambient temperature conditions change significantly, there may be minor over or undershoots as the incubator adapts.

The incubator relies on natural heat radiation for cooling. The unit can achieve a low-end temperature just above the ambient room temperature plus the internal waste heat of the unit.

The outer chamber door is self-heating to bolster the thermal uniformity and stability of the chamber and to minimize condensation on the glass viewing door. The inner glass door will cool while the chamber door is opened, eventually leading to condensate on the door and impacting the chamber temperature stability and uniformity. Minimize sample viewing times when possible.



### **Humidification**

Passive humidification is provided by filling the humidification pan included with the unit. The pan is then placed on the heated chamber floor. Evaporation, driven in part by heating, raises the relative humidity percentage (RH%) of the chamber. A copper token included with the pan helps to significantly slow the growth of microbiological populations in the humidification water supply.

The incubator must be humidified in order to achieve its stated temperature uniformity specification.

## Set CO<sub>2</sub> % CO<sub>2</sub> Atmosphere

The incubator also controls and maintains the gas concentration of CO<sub>2</sub> in the chamber atmosphere by operating an internal injection solenoid valve connected to a gas input port. The incubator monitors the CO<sub>2</sub> concentration level in the chamber using an infrared sensor located in the recirculation duct. The sensor operates on the principle that a specific frequency set of infrared light is absorbed by CO<sub>2</sub>. The more CO<sub>2</sub> present in the chamber, the more of that band of infrared is absorbed. The sensor is only sensitive to CO<sub>2</sub>, so measurement accuracy is consistent, regardless of the presence of other gases in the incubator.

The incubator uses Proportional – Integral – Derivative (PID) control to avoid significantly overshooting the CO<sub>2</sub> setpoint. This means the rate of injection slows as the chamber CO<sub>2</sub> concentration approaches the target CO<sub>2</sub> concentration. When the chamber concentration is stable CO<sub>2</sub> injections take place in small bursts to correct for deviations less than 0.1%. The incubator is not provided with a means to actively remove CO<sub>2</sub> from the chamber atmosphere.



### The Over Temp Safety System

The over temperature limit system (OTL) is a user-set, mechanical heating cutoff connected to a hydrostatic sensor probe inside the incubation chamber. The system operates independently of the main microprocessor temperature controller and routes power away from the incubator heating elements if the chamber temperature exceeds the OTL temperature cutoff setting. It will continue doing so as long as the chamber temperature remains above the OTL setting. This helps safeguard the unit by preventing runaway heating in the event of electronics failures or a sudden external heat spike.

**The OTL must be set by the user in order to function.** The manufacturer recommends a setting of approximately 1°C above the highest temperature setpoint of your heating application. A red indicator illuminates when the OTL is rerouting power. Failure to set the Over Temperature Limit system voids the unit manufacturing defect warranty in the event of an overtemperature event.



### Physical and Data Access

An access port on the right side of the unit allows sensors such as thermocouple probes to be inserted and left in the chamber without compromising the CO<sub>2</sub> atmosphere or chamber temperature. An atmosphere sample port for independently verifying the CO<sub>2</sub> concentration in the chamber is provided on the right side of the unit. A USB outputs CO<sub>2</sub> and temperature levels once per minute as a serial-protocol digital log line. Jack ports on the back of the unit provide the same outputs as analog 4 – 20 milliamp signals for use by a building monitoring system. Please see the [Data Output Capabilities](#) entry on page 41 for more details.

# OPERATION

**Note:** From a cold start, the incubator requires 8 hours to come up to and stabilize at temperature and humidity levels prior to loading samples. Stabilization safeguards samples.



## PUT THE INCUBATOR INTO OPERATION

Perform the procedures below after the unit has been installed in a new workplace location. These prepare the incubator for normal use.

1.



Attach the power cord that came with the unit to the power inlet receptacle on the side of the incubator.

2.

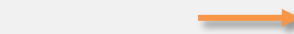

Plug the power cord into the workspace electrical supply outlet.

3.

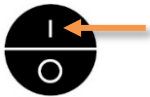

Turn on the incubator.

- Place the incubator **Power Switch** in the ON ( I ) position.



4.

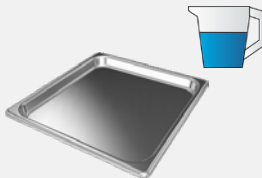

Perform the [Humidify the Incubator](#) procedure on page 33.



5.



Carry out the [Set the Temperature Setpoint](#) procedure on page 34. Set the incubator to your incubation application temperature.

6.

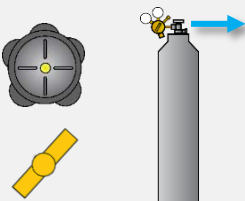

Perform the [Start a CO<sub>2</sub> Flow](#) procedure on page 36.

7.

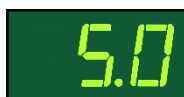

Carry out the [Set the CO<sub>2</sub> Setpoint](#) procedure on page 37. Set the CO<sub>2</sub> setpoint to your application gas concentration.

# OPERATION

Continued from the previous page.

8.



Wait 8 Hours

Run the unit for at least **8 hours** (for example, overnight) with chamber doors closed prior to:

- Setting the Over Temperature Limit (next step).
- Loading samples.

This helps ensure a stable temperature environment.



9.

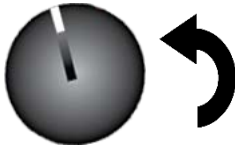

Perform the [Set the Over Temperature Safety](#) procedure on page 39.

- The incubator must be heated **and stable** at your application temperature prior to performing this procedure.

**The incubator is now ready for use.**

- You may now [Load Samples](#) into the incubator. Please see page 40.

# OPERATION

**Note:** Each SCO10A incubator chamber must be independently humidified.



## *HUMIDIFY THE INCUBATOR*

The humidification pan must be filled with water in order for the incubator to achieve its stated temperature uniformity specification.

Humidifying the chamber helps slow the drying of samples in open, “breathable” containers.



- **Never use deionized water** to humidify the incubator.
- The pan must be placed on the chamber floor.
  - The floor is heated and helps evaporation to raise the humidity level to 90 – 95% relative humidity.
- Regularly clean and disinfect the pan.
- Refill as needed and change the water in the pan at least once per week.
- Adding chemical disinfectants to the pan may alter the surface tension of the water. This can significantly reduce the rate of evaporation and impact the humidity level of the incubator chamber.

# OPERATION

**Note:** Each SCO10A incubator chamber temperature must be set independently.



## SET THE TEMPERATURE SETPOINT

Perform the steps below to adjust the setpoint to your process or application temperature.

### 1. Set the Over Temperature Limit control to its maximum setting, if not already set to max.

- This prevents the heating cutoff system from interfering with this procedure.

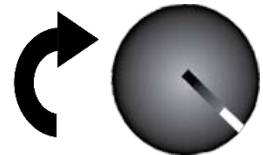

### 2. Navigate to the Temperature Setpoint Adjustment mode



Briefly push and release either the **Up** or **Down** arrow buttons to activate the temperature setpoint adjustment mode.

- The display will briefly flash the letters "SP", then show the flashing, adjustable temperature setpoint.

**Note:** The display will automatically exit the adjustment mode after 5 seconds of inactivity, with the last shown setpoint value saved.



Setpoint Adjustment Mode



Initial Setpoint

### 3. Set the Temperature Setpoint



Use the Up and Down arrow buttons to change the temperature setpoint.



New Setpoint

### 4. Wait for 5 seconds after entering the Setpoint



Wait 5 Seconds

- The display will stop flashing, and the setpoint is now saved in the controller.
- The chamber will now automatically heat or passively cool to match your setpoint.
- The display will revert to showing the current chamber air temperature.

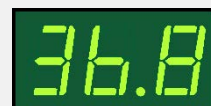

Heating to New Setpoint

**End of Procedure**

## *MUTING THE AUDIBLE TEMPERATURE ALARM*

Audible and visual deviation alarms activate if the incubation chamber temperature deviates by 1°C above or below the temperature setpoint. The low deviation alarm has a delay of 15 minutes to prevent the low alarm from sounding each time the doors are opened, causing a short-lived drop in temperature.

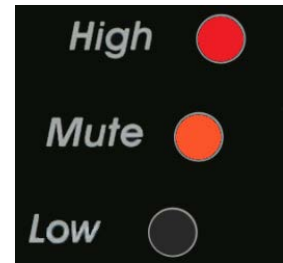

**High Alarm Muted**

**To mute an audible high or low deviation alarm:**



Press and hold either the **Up** or **Down** arrow button on the Temperature Control until the amber Mute LED illuminates and the audible alarm shuts off.

- The audible alarm will remain muted for the duration of the current temperature deviation.
- The visual alarm indicator will remain illuminated.
- Any **new** deviation of  $\pm 1^\circ\text{C}$  or greater will reactivate the audible alarm.

## *AUTOMATIC DOOR CUTOFFS*

**Gas, heating, and air circulation pause.**

Whenever the outer incubation chamber door is opened, the incubator automatically stops the flow of CO<sub>2</sub> into the chamber, depowers the heater element, and ceases operation of the internal blower fan. This limits the amount of CO<sub>2</sub> released into the workspace around the incubator. It also prevents the heater from attempting to counteract the continuous inflow of cooler air, which would cause a significant heat spike once the door is closed. Normal CO<sub>2</sub> injections, heating, and fan operation all resume automatically when the outer door is closed.

# OPERATION

**Note:** Ensure that each incubation chamber in the SCO10A is connected to its own CO<sub>2</sub> supply.

## START A FLOW OF CO<sub>2</sub>



### Gas Cylinder



1. Open the cylinder valve to supply CO<sub>2</sub> to the regulator.



2. Set the cylinder regulator flow setting.

- Set the regulator to deliver 15 – 20 Pounds per Square Inch (psi) to the incubator CO<sub>2</sub> in Port. **Never exceed 20 psi.**

### Building Supply System

1. Initiate a flow to supply 15 – 20 psi of CO<sub>2</sub> to the incubator through the Gas In port.

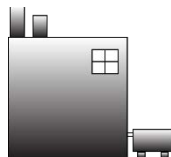

PSI	Megapascals	Kilopascals	Bar
15 – 20 psi	0.103 – 0.137 Mpa	103.42 – 137.89 Kpa	1.03 – 1.378 bar

# OPERATION

**Note:** Each SCO10A incubator chamber CO<sub>2</sub> setpoint must be set independently.

## SET THE CO<sub>2</sub> SETPOINT

The incubator comes from the factory with the CO<sub>2</sub> setpoint set to Off. Set the setpoint percentage to the gas concentration required by your study or production protocol.

### 1. Navigate to the CO<sub>2</sub> Setpoint Adjustment mode



Briefly push and release either the **Up** or **Down** arrow buttons to activate the CO<sub>2</sub> setpoint adjustment mode.

- The display will briefly flash the letters "SP", then show the flashing, adjustable CO<sub>2</sub> setpoint.

**Note:** The display will automatically exit the adjustment mode after 5 seconds of inactivity, with the last shown setpoint value saved.

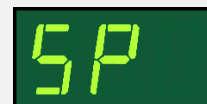

Setpoint Adjustment Mode

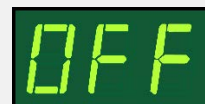

Initial Setpoint

### 2. Set the CO<sub>2</sub> Setpoint



Use the Up and Down arrow buttons to change the CO<sub>2</sub> setpoint.

**Note:** To turn the CO<sub>2</sub> system off, set the setpoint to its lowest setting (OFF).



New Setpoint

### 3. Wait for 5 seconds after entering the Setpoint



Wait 5 Seconds

- The display will stop flashing, and the setpoint is now saved in the controller.
- The chamber will now automatically begin injecting CO<sub>2</sub> or allowing the current concentration to decay to match your setpoint.
- The display will revert to showing the current chamber CO<sub>2</sub> concentration.

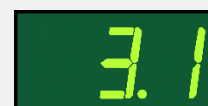

CO<sub>2</sub> Injecting

### Low CO<sub>2</sub> (LO)

When starting with no CO<sub>2</sub> in the chamber, the display will show "LO" until the incubator registers a concentration greater than 0%. A few minutes of CO<sub>2</sub> injections may be required to build up a sufficient gas concentration.

End of Procedure

## MUTING THE AUDIBLE CO<sub>2</sub> ALARM

Audible and visual deviation alarms activate if the incubation chamber CO<sub>2</sub> concentration deviates by 1% above or below the CO<sub>2</sub> setpoint. The low deviation audible alarm has a delay of 15 minutes to prevent the low alarm from sounding each time the doors are opened, causing a short-lived drop in CO<sub>2</sub> concentration.



To mute a CO<sub>2</sub> deviation alarm:



Press and hold either the **Up** or **Down** arrow button on the CO<sub>2</sub> Control until the amber Mute LED illuminates and the audible alarm shuts off.

Low Gas Alarm Muted

- The audible alarm will remain muted for the duration of the current CO<sub>2</sub> deviation.
- The visual alarm indicator will remain illuminated.
- Any **new** deviation of  $\pm 1\%$  or greater will reactivate the audible alarm.



Low and No Gas Alarms Timeline

## NO GAS SUPPLY ALARM (NGS)

A second alarm activates if the Low Gas deviation indicator light is illuminated for longer than 20 minutes.

- The letters “ngs” will appear in the CO<sub>2</sub> display indicating **No Gas Supply**.
- The alarm will remain active, even if the incubator is turned off and back on.
- The NGS alarm remains on until CO<sub>2</sub> is restored to the chamber. It may take 2 or more minutes of CO<sub>2</sub> injections to establish a concentration high enough to deactivate the alarm.



# OPERATION

**Note:** Test the OTL system at least once per year to verify its functionality. **Failure to set the OTL voids the manufacturing defect warranty if over temperature damage occurs.**

**Note:** The OTL for each SCO10A incubator chamber must be set independently.

## SET THE OVER TEMPERATURE SAFETY



This procedure sets the mechanical heating cutoff to approximately 1°C above the current chamber temperature. **Perform this procedure when the unit has been running with no temperature fluctuations at your application temperature for at least 8 hours.**

**1. Set OTL control to its maximum setting, if not already set to max.**

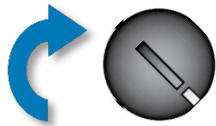

**2. Turn the dial counterclockwise (to the left) until the Over Temperature Activated light illuminates.**



- There is a soft click when the OTL begins rerouting power away from the heating elements.

**3. Slowly turn the dial clockwise (to the right) until the Over Temperature light turns off.**

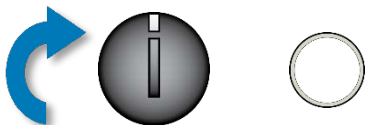

- The Over Temperature Limit is now set approximately 1°C above the current chamber air temperature.

**4. Leave the OTL dial set just above the activation point.**



**Optional:** Turn the dial slightly to the left (counterclockwise).



- This sets the cutoff threshold nearer to the current chamber temperature.

If the Over Temperature Limit sporadically activates after setting the control, turn the dial very slightly to the right (clockwise). If the OTL continues activating, check for ambient sources of heat or cold that may be adversely impacting the unit temperature stability. If you find no sources of external or internal temperature fluctuations, contact Customer Support or your distributor for assistance.

**End of Procedure**

## *LOADING SAMPLES*

The manufacturer strongly recommends waiting at least **8 hours** after putting the incubator in operation before loading samples in the chamber. This safeguards against temperature instability.

- Samples should be placed at least 1 inch (25 mm) away from the chamber walls.
- Samples or sample stacks should be spaced 1 inch (25 mm) apart.
- Proper spacing allows for maximum air circulation and a higher degree of temperature uniformity.
- Proper spacing also decreases the chance of condensate forming in the incubator when operating with a large number of samples in the chamber.

## *ACCESSORY COMPATIBILITY*

- Verify that any powered accessory equipment used inside the chamber can safely and effectively operate within your selected temperature, humidity, and CO<sub>2</sub> concentration range.
- Powered equipment, such as stirrers or shakers, can generate heat sufficient to disrupt the thermal uniformity and stability of the chamber.

## DATA OUTPUT CAPABILITIES

### USB Outputs



The incubator generates data outputs describing the chamber temperature and CO<sub>2</sub> concentration percentage as a digital log line, once per minute. These outputs are transmitted through a USB port located on the back of the unit using RS232 serial protocol.

### Required Software

Viewing and logging this output requires a terminal emulator program such as the open source (BSD license) emulator, Tera Term.

### Digital Outputs

Parameter	Output Channel
Temperature	C1
CO <sub>2</sub>	C3

Example logline output: **C1=37.0 C3=5.0**



### Analog Outputs

The temperature and CO<sub>2</sub> levels are also outputted as analog signals by an internal 4-20 milliamp board. The outputs are transmitted through two jack ports on the back of each incubator unit. The ports connect to a standard audio jack and cable (male mono phono plug, ¼ inch (6.3 mm)).

Jacks are **not** included with the incubator.



### Jack Outputs

Parameter	Parameter Value at 4mA	Parameter Value at 20mA
Temperature	0°C	70°C
CO <sub>2</sub>	0% CO <sub>2</sub>	20% CO <sub>2</sub>

### Data Monitoring Systems – Max Resistance

For building management and other data monitoring or logging systems, the maximum resistance of the current loop driven by either output from the 4-20mA module is 250 Ohms. At higher loop resistances, the current value will be erroneously low for parameter values near the top of the scale.

## *CONDENSATION AND THE DEW POINT*



**Relative humidity inside the incubator chamber should never be allowed to exceed 95%.** Exceeding this threshold will likely result in condensation, possible leaks around the incubator, and may cause corrosion damage if allowed to continue for any significant length of time.

Condensation takes place whenever the humidity level in the incubator chamber reaches the dew point. The dew point is the level of humidity at which the air cannot hold more water vapor. The warmer the air, the more water vapor it can hold.

As the level of humidity rises in an incubation chamber, condensate will first appear on surfaces that are cooler than the air temperature. Near the dew point, condensate forms on any item or exposed surface even slightly cooler than the air. When the dew point is reached, condensate forms on nearly all exposed surfaces.

Managing condensation primarily depends on either lowering the humidity level or increasing the air temperature in the incubator chamber.

---

**Note:** Rising or falling air pressure from the weather will adjust the dew point up and down in small increments. If the relative humidity in the incubation chamber is already near the dew point, barometric fluctuations may push it across the dew point threshold.

**Note:** Thin air at higher altitudes holds less humidity than the denser air found at or near sea level.

---

If excessive condensate has appeared in the incubation chamber, dry the chamber interior and check the following.

- Verify that the access port stopper is in place on the inside of the incubation chamber and not the unit exterior.
- Make sure samples on the shelves are evenly spaced to allow for good airflow.
- Ensure the chamber door is closing and latching properly.
- Are frequent or lengthy chamber door openings causing significant temperature disruptions and chilling the chamber surfaces? If so, reduce the number of openings.
- Are there too many open containers of evaporating sample media in the chamber? If so, reduce the number of open sample containers.
- Does the ambient humidity in the room exceed the stated operating range of 80% relative environmental humidity? If so, lower the room humidity.
- Is the incubator exposed to an external flow of cold air such as an air-conditioning vent or a door to a cooler hallway or adjacent room? Block or divert the air, or reposition the unit.
- Check the door gaskets for damage, wear, or signs of brittleness or dryness. Arrange for replacement of the gaskets if damaged or excessively worn.

# USER MAINTENANCE



**Warning:** Disconnect the unit from its power supply prior to performing maintenance or services.

**Avertissement:** Débranchez cet appareil de son alimentation électrique avant d'effectuer la maintenance ou les services.

## *CLEANING AND DISINFECTING*

If a hazardous material or substance has spilled in the unit chamber, immediately initiate your site Hazardous Material Spill Containment protocol. Contact your local Site Safety Officer and follow instructions per the site policy and procedures.

- Periodic cleaning and disinfection are required.
- Do not use spray-on cleaners or disinfectants. These can leak through openings and coat electrical components.
- Consult with the manufacturer or their agent if you have any doubts about the compatibility of decontamination or cleaning agents with the parts of the equipment or with the material contained in it.
- Do not use cleaners or disinfectants that contain solvents capable of harming paint coatings or stainless-steel surfaces. **Do not use chlorine-based bleaches or abrasives; these will damage the chamber liner.**
- **Do not clean or disinfect the ring-style chamber HEPA filter.** Replace the filter if discolored or if you believe it has been contaminated.



**Warning:** Exercise caution if cleaning the unit with alcohol or flammable cleaners. Always allow the unit to cool down to room temperature prior to cleaning and make sure all cleaning agents have evaporated or otherwise been completely removed prior to putting the unit back into service.

**Avertissement:** Soyez prudent lorsque vous nettoyez l'appareil avec de l'alcool ou des produits de nettoyage inflammables. Laissez toujours refroidir l'appareil à la température ambiante avant le nettoyage et assurez-vous que tous les produits de nettoyage se sont évaporés ou ont été complètement enlevés avant de remettre l'appareil en service.

### Cleaning

1. Disconnect the unit from its power supply.
2. Remove all removable interior components such as shelving and accessories.
3. Clean the unit with a mild soap and water solution, including all corners.
  - **Do not use abrasive cleaners**, these will damage metal surfaces.
  - **Do not use deionized water to rinse or clean with.**
  - Take special care when cleaning around the temperature sensor probes in the chamber to prevent damage. Do not clean the probes.
4. Rinse with distilled water and wipe dry with a soft cloth.

## Disinfecting

For maximum effectiveness, disinfection procedures are typically performed after cleaning. Keep the following points in mind when disinfecting the unit.

- Turn off and disconnect the unit to safeguard against electrical hazards.
- Disinfect the unit chamber using commercially available disinfectants that are non-corrosive, non-abrasive, and suitable for use on stainless steel and glass surfaces. Contact your local Site Safety Officer for detailed information on which disinfectants are compatible with your applications.
- If permitted by your protocol, remove all removable interior accessories (shelving and other non-attached items) from the chamber when disinfecting.
- Disinfect all surfaces in the chamber, making sure to thoroughly disinfect the corners. Exercise care to avoid damaging the sensor probes.
- Gas concentrations from evaporating disinfecting agents can inhibit growth or cause metabolic symptoms in microbiological sample populations. Make sure that chlorines, quaternary ammonias, or any other overtly volatile disinfecting agents have been rinsed or otherwise removed from the chamber surfaces, prior to placing samples in the chamber.

When disinfecting external surfaces, use disinfectants that will not damage painted metal, glass, and plastic.

## *MINIMIZING CONTAMINATION EXPOSURE*

Suggestions for minimizing exposure of the incubator chamber to potential contaminants.

- Maintain a high air quality in the laboratory workspaces around the incubator.
- Avoid placing the incubator near sources of air movement such as doors, air vents, or high traffic routes in the workspace.
- Minimize the number of times the incubator chamber door is opened during normal operations.

## *MAINTAINING ATMOSPHERIC INTEGRITY*

Periodically, inspect the door latch, trim, catch, and gaskets for signs of deterioration. Failure to maintain the integrity of the door system shortens the lifespan of the incubator.

## *GAS LINES AND HEPA FILTERS*

### **For the Optional Filtered Gas Tubing Kit**

The manufacturer recommends replacing the in-line gas HEPA filters once per year or when a filter is noticeably discolored.

- HEPA filters are directional and must be installed facing in the correct direction.
- The word "IN" is stamped on the rim of the filter assembly on the side facing the gas supply. See page 22.

Gas lines should be replaced when cracking, brittleness, permanent kinking, or other signs of damage are present.

"IN"



**In-Line Gas Filter**

## *ELECTRICAL COMPONENTS*

Electrical components do not require maintenance. If the incubator fails to operate as specified, please contact your distributor or [Customer Support](#) for assistance (please see page 8).

## *STORING THE INCUBATOR*

Perform the following steps if the incubator will be out of use for more than 24 hours to prevent microbiological contamination such as fungus or mold.

1. Depower the incubator.
2. Disinfect and clean if required by your laboratory protocol, or if the chamber has been exposed to pathogenic microorganisms.
3. Use a soft cloth to dry the chamber surfaces.

## REPLACE THE CHAMBER HEPA FILTER

**Note:** Always turn off and unplug the incubator before carrying out this procedure.

Replace the filter at least once per year, or when the filter is noticeably discolored.

**Exercise caution** when removing the ceiling air duct. A plastic blower fan and the fragile head of the temperature and CO<sub>2</sub> sensors are located just above the duct and just to the right of the duct.

### Dismount the Air Duct (Ceiling Liner)

5. Use firm but careful pressure to remove the duct from the front mounting pins, one pin at a time.
6. Dismount the back of the duct from the rear mounting pins by carefully pushing the back of the duct.
7. Lower the front of the duct. This safeguards against accidentally striking the blower fan and sensor heads with the duct.
8. Pull the duct and attached HEPA filter out of the incubation chamber.

### Replacing the HEPA Filter

9. Remove the black plastic cap from the HEPA filter by pulling down on it.
10. Remove the old HEPA filter by pulling down. It will snap out without difficulty.
11. Snap the new HEPA filter into position on the duct. It may be necessary to tilt it slightly to one side.
  - See the [Install Chamber HEPA Filter and Duct](#) procedure on page 20 for detailed instructions on installing a new filter.
12. Snap the black plastic cap back into position in the center of the HEPA filter.

### Reinstall the duct

13. See the [Install Chamber HEPA Filter and Duct](#) procedure on page 20 for detailed instructions on reinstalling the duct.

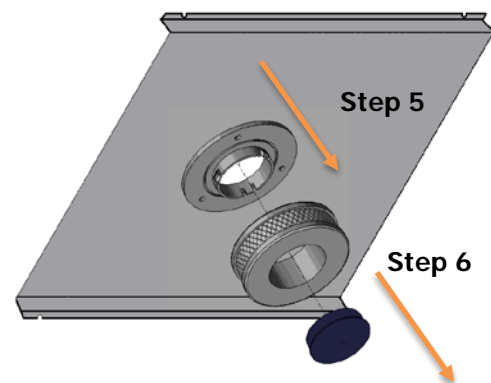
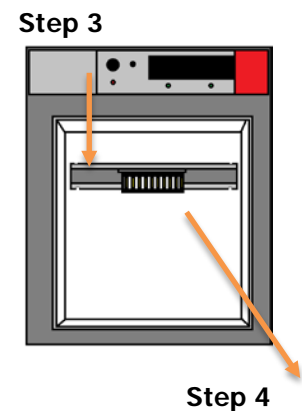
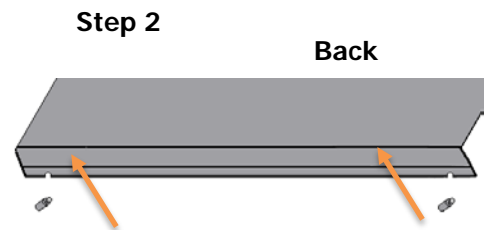
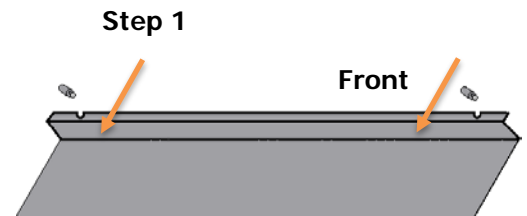

## CALIBRATE THE TEMPERATURE DISPLAY

**Note:** This procedure requires a temperature reference device. Please see the [Reference Sensor Device entry](#) on page 10 for the device requirements.



**Note:** Each SCO10A incubation chamber must be independently calibrated to its temperature display.

Temperature calibrations match the temperature display to the actual air temperature inside the incubation chamber. The actual air temperature is supplied by a reference sensor device. Calibrations compensate for software drifts in the controller as well as deviations caused by the natural material evolution of the sensor probe in the heated chamber space. Calibrate as often as required by your laboratory or production protocol, or regulatory compliance schedule. Always calibrate to the industry or regulatory standards required for your application.

### Humidity

Humidity affects temperature uniformity and stability in the incubation chamber. The chamber must be humidified for at least 24 hours in order to conduct an accurate calibration.

### A Suggested Calibration Set-Up

1. Introduce the reference device thermocouple sensor probe through the access port on the right side of the incubator.
2. Position the probe in the chamber.
  - Place the probe head as close as possible to the geometric center point of the chamber.
  - The probe head must be at least 2 inches (51 mm) from the surface of the shelving to prevent heatsinking.
3. Secure the probe head in position with the non-marking, heat-resistant tape.
4. Carefully place the access port stopper in the port over the probe wires. Use non-stick tape to seal any gaps created between the stopper and the port by the probe wires.
5. The incubator door must be closed and latched. Failure to do so will prevent an accurate calibration.

Use non-marking, heat-resistant polyamide tape to hold the thermocouple probe in place. The manufacturer recommends Kapton brand tape, 0.5 inches width (12.7 mm), 2 mil thickness.



**CO<sub>2</sub> Calibration:** A CO<sub>2</sub> calibration may be performed during the temperature calibration so long as the chamber door and access port remain closed and sealed.

# MAINTENANCE

6. The unit temperature must be stable in order to perform an accurate calibration.

- The incubator must run for at least 8 hours prior to conducting a calibration.
- The temperature is considered stabilized when the incubator has operated with the door closed at your calibration temperature for at least 1 hour with no fluctuations greater than the specified stability of the unit (see page 56).

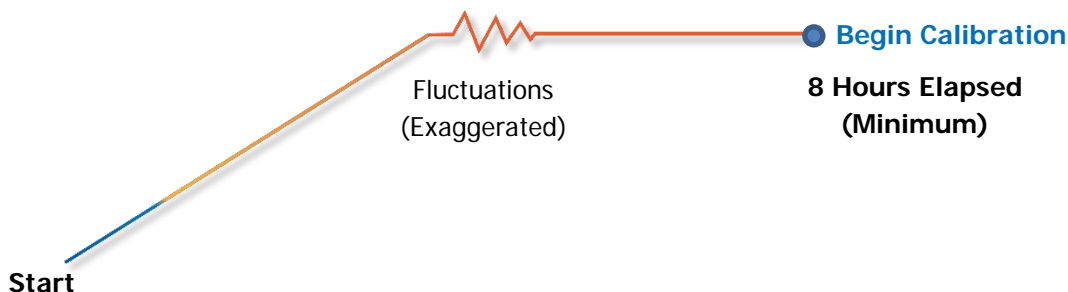

## Suggested Temperature Calibration

1

Once the incubator temperature has stabilized, compare the reference device and incubator temperature display readings.

- If the readings are the same, or the difference between the two falls within the acceptable range of your protocol, the display is accurately showing the incubation chamber air temperature. **The Temperature Calibration procedure is now complete.**

Reference Device

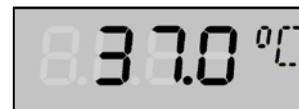

Set Temperature



-OR-

- If the difference falls outside of your protocol range, advance to Step 2.

2

A display calibration adjustment must be entered to match the display to the reference device. See the next step.

Reference Device

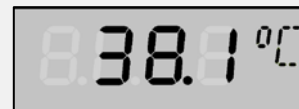

Continued next page

## Temperature Calibration Continued

3



Place the display in temperature calibration mode.

- Press and hold both the **Up** and **Down** temperature arrow buttons simultaneously for approximately 5 seconds.
- Release the buttons when the temperature display shows the letters "C O". The display will begin flashing the **current temperature display value**.



Note: The display will automatically exit calibration mode after 5 seconds of inactivity, with the last shown temperature display value saved.

4



Use the **Up** or **Down** arrows to adjust the current display temperature value until it matches the reference device temperature reading.

Reference Device



5



Wait 5 Seconds

After matching the display to the reference device, wait 5 seconds.

- The temperature display will cease flashing and store the corrected chamber display value.
- The incubator will now begin heating or passively cooling in order to reach the setpoint with the corrected display value.



Cooling to Setpoint

6



Wait 1 Hour

Allow the incubator to operate for at least 1 hour undisturbed to stabilize **after the incubator has achieved the corrected temperature setpoint**.

- Failure to wait until the incubator is fully stabilized will result in an inaccurate reading.



Setpoint Achieved

Continued next page

## Temperature Calibration Continued

7

Compare the reference device reading with the chamber temperature display.

- If the reference device and the chamber temperature display readings are the same or the difference falls within the range of your protocol, **the incubator is now calibrated for temperature.**

-OR-

- See the next step if the readings fail to match or fall outside of your protocol range.

Reference Device

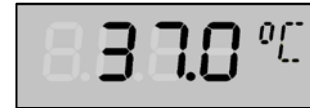

8

If the difference still falls outside the acceptable range of your protocol, repeat steps 3 – 7 up to two more times.

Reference Device



9

If the temperature readings of the incubator temperature display and the reference device still fall outside your protocol after 3 calibration attempts, contact your distributor or customer support for assistance.

**End of Procedure**

## *CALIBRATE THE CO<sub>2</sub> DISPLAY*

**Note:** This procedure requires a gas reference device. Please see the [Reference Sensor Devices entry](#) on page 10 for the device requirements.

**Note:** Each SCO10A incubation chamber must be independently calibrated to its CO<sub>2</sub> display.

Gas calibrations are performed to match the incubator CO<sub>2</sub> display to the actual CO<sub>2</sub> concentration inside the incubation chamber. The actual gas concentration is supplied by a calibrated reference device. Calibrations compensate for long-term drifts in the incubator microprocessor controller as well as those caused by the natural material evolution of the infrared sensor in the heated recirculation duct space. Calibrate as often as required by your laboratory or production protocol, or regulatory compliance schedule. Always calibrate to the standards and use the calibration setup required by your industry requirements or laboratory protocol.

### **Humidity**

Because humidity impacts CO<sub>2</sub> concentration through its influence on temperature stability and uniformity, the CO<sub>2</sub> display should be calibrated with the chamber humidified.

### **A suggested calibration setup**

1. Connect the reference device sample tubing to **CO<sub>2</sub> Sample Port** located on the top, right side of the incubator.
2. The incubation chamber door must be closed and latched. Failure to do so will prevent accurate calibration.
3. CO<sub>2</sub> calibrations must be performed with the chamber **fully heated and stable at your application temperature setpoint**. Temperature helps drive gas diffusion in the chamber.
4. The incubator must be supplied with CO<sub>2</sub> during the entire calibration procedure.

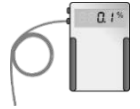

# MAINTENANCE

5. The CO<sub>2</sub> concentration in the incubation chamber must be stable in order to perform an accurate calibration.

- The unit must be thermally stable, having operated at your application temperature for **at least 8 hours** prior to starting the gas calibration.
- After turning on a flow of CO<sub>2</sub> to the chamber and setting the CO<sub>2</sub> setpoint, allow the incubator to operate undisturbed with the chamber door shut for **at least 2 hours**.
- To be considered stabilized, the incubator chamber must operate at your calibration CO<sub>2</sub> concentration for **at least 30 minutes with no fluctuations of  $\pm 0.1\%$  or greater**.

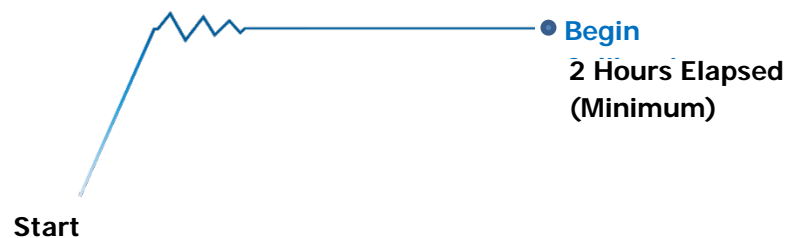

## A Suggested CO<sub>2</sub> Calibration

1

Once the incubator CO<sub>2</sub> concentration has stabilized, compare the reference device and the CO<sub>2</sub> display readings.

- If the readings are the same, or the difference between the two falls within the acceptable range of your protocol, the display is accurately showing the incubation chamber CO<sub>2</sub> concentration. **The CO<sub>2</sub> Calibration procedure is now complete.**

Reference Device

8 5.0 %

Set CO<sub>2</sub> %

5.0 ✓

-OR-

- If the difference falls outside of your protocol range, advance to Step 2.

2

A display calibration adjustment must be entered to match the display to the reference device. See next step.

Reference Device

8 5.8 %

5.0 ✗

Continued next page

## CO<sub>2</sub> Calibration Continued

- 3 Place the incubator CO<sub>2</sub> display in its calibration mode.



- Press and hold both the **Up** and **Down** CO<sub>2</sub> arrow buttons simultaneously for approximately 5 seconds.
- Release the buttons when the CO<sub>2</sub> display shows the letters "C O". The display will then begin flashing the current CO<sub>2</sub> display value.



Note: The display will automatically exit calibration mode after 5 seconds of inactivity, with the last shown CO<sub>2</sub> display value saved.

4



Use the **Up** and **Down** arrow buttons to adjust the current display CO<sub>2</sub> % value until it matches the reference device concentration reading.

Reference Device



5

After matching the display to the reference device, wait 5 seconds.



Wait 5 Seconds

- The gas display will cease flashing and store the corrected chamber display value.
- The incubator will now begin injecting CO<sub>2</sub> or allowing the current concentration to decay in order to achieve the setpoint with the corrected display value.

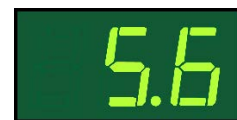

Decaying to Setpoint

6



Wait 1 Hour

Allow the incubator to sit for at least 1 hour undisturbed to stabilize **after the incubator has achieved the corrected gas setpoint**.

- Failure to wait until the incubator is fully stabilized will result in an inaccurate reading.



Setpoint Achieved

Continued next page

## CO<sub>2</sub> Calibration Continued

7

Compare the reference device reading with the incubator CO<sub>2</sub> display again.

- If the reference device and the incubator display readings are the same or the difference falls within the range of your protocol, **the incubator is now calibrated for CO<sub>2</sub>**.

Reference Device



-OR-

- See the next step if the readings fail to match or fall outside of your protocol range.



8

If the difference still falls outside the acceptable range of your protocol, repeat steps 3 – 7 up to two more times.

Reference Device



9

If the gas concentration readings of the incubator CO<sub>2</sub> display and the reference device still fall outside your protocol after 3 calibration attempts, contact your distributor or customer support for assistance.

**End of Procedure**

# UNIT SPECIFICATIONS

These incubators are 110 – 120 volt units. Please refer to the unit data plate for individual electrical specifications.

Technical data specified applies to units with standard equipment at an ambient temperature of 25°C and at nominal voltage. The temperatures specified are determined in accordance with factory standard following DIN 12880 respecting the recommended wall clearances of 10% of the height, width, and depth of the inner chamber. All indications are average values, typical for units produced in the series. We reserve the right to alter technical specifications at all times.

## *WEIGHT*

Model	Shipping	Unit
SCO5A	238 lb / 108 kg	200.0 lb / 91.0 kg
SCO10A	460 lb / 209 kg	400.0 lb / 182.0 kg

## *DIMENSIONS*

### Unit Body

In inches

Model	Exterior W × D × H	Interior W × D × H
SCO5A	27.5 x 28.5 x 37.8	20.5 x 19.8 x 21.5
SCO10A	27.5 x 28.5 x 75.6	20.5 x 19.8 x 21.5*

\*Interior dimensions for the SCO10A are for each chamber

In millimeters

Model	Exterior W × D × H	Interior W × D × H
SCO5A	699 x 724 x 960	521 x 503 x 546
SCO10A	699 x 724 x 1921	521 x 503 x 546*

\*Each Chamber

### Access Port

Inner Diameter
1.3 in      33 mm

# SPECIFICATIONS

## MAX SHELVES FOR UNIT

Model	Shelves
SCO5A	8
SCO10A	16

## CAPACITY

Model	Cubic Feet	Liters
SCO5A-2	5.0	142.0
SCO10A-2*	5.0	142.0

Degree of Ingress Protection
IP20

\*Each Chamber

## CO<sub>2</sub>

Model	Range	Accuracy	Recovery Time
All	0 – 20%	± 0.1%	Less than 5 minutes

## TEMPERATURE

Model	Range	Uniformity	Stability
All	Ambient +5°C to 60°C	± 0.25°C at 37°C	± 0.1°C @ 37°C

## POWER

Model	AC Voltage	Amperage	Frequency
SCO5A	110 – 120	6.0	50/60 Hz
SCO10A	110 – 120	12.0 (6.0 each chamber)	50/60 Hz

Pollution Degree 2	
Equipment being evaluated to 60950	
Laboratories	
Test Stations	
Office Environment	

# PARTS LIST

Part	Part Number	Part	Part Number
Access Port Stopper	 <b>7750506</b>	Gas Line HEPA Filter	 <b>2800525</b>
Chamber HEPA Filter	 <b>2800517</b>	Humidification Pan	 <b>7930514</b>
Chamber HEPA Filter Cap	 <b>6500506</b>	Leveling Foot	 <b>2700512</b>
Ceiling Air Duct (Chamber)	 <b>5121527</b>	Power Cord 115 volt 15 Amp, 9ft 5 in (2.86m) NEMA 5-15P	 <b>1800510</b>
CO <sub>2</sub> Gas Tubing Kit with In-Line HEPA Filter	 <b>9710500</b>	Shelf Slides	 <b>5121526</b>
Fuse T10A 250V 5X20mm	 <b>3300516</b>	Shelf Standards	 <b>5170646</b>
		Shelf	 <b>5121525</b>

## *ACCESSORIES*

The following accessories are available for the SCO5A and SCO10A

### **CO<sub>2</sub> Cylinder Regulator, Dual Stage**

For use with a gas supply cylinder (tank).

Part Number 7150509



### **Copper Shelf Kit**

Includes 3 copper shelves and 6 copper shelf slides. Copper is known to have antimicrobial properties.

Part Number: 9750582 complete assembly described above.

PN 5820504 Individual Shelf      PN 5820505 Pair of Slides

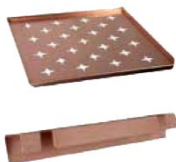

## *ORDERING PARTS AND ACCESSORIES*

Please visit the Products page on our website at [sheldonmanufacturing.com](http://sheldonmanufacturing.com) to find accessories and replacement parts.

If the required item is not listed online, or if you require assistance in determining which part or accessory you need, contact Sheldon Manufacturing, Inc. by emailing [support@sheldonmfg.com](mailto:support@sheldonmfg.com) or by calling 1 (800) 322-4897 ext. 4 or (503) 640-3000 ext. 4.

To ensure the fastest service when you contact Tech Support, please have the following details ready. This information allows us to quickly match your unit to the correct part it needs:

- Model number
- Serial number
- Part number(s)
- Part ID

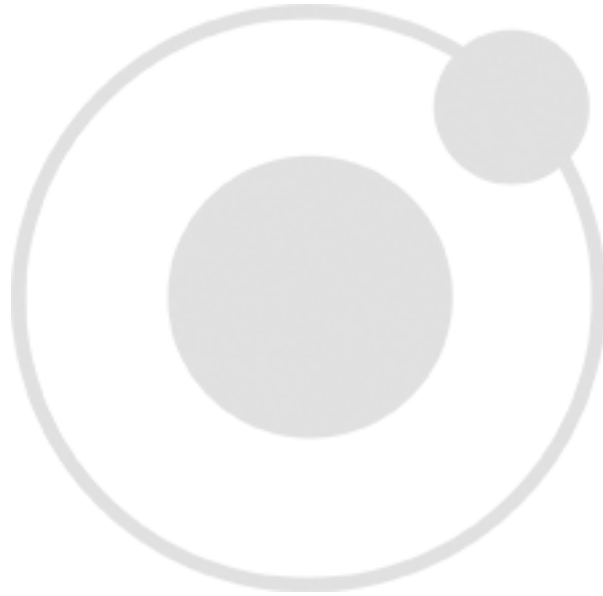



P.O. Box 627  
Cornelius, OR 97113  
USA

[support@sheldonmfg.com](mailto:support@sheldonmfg.com)  
[sheldonmanufacturing.com](http://sheldonmanufacturing.com)

1-800-322-4897  
(503) 640-3000